

CANCIO

NEWS 2018



Cancio Fábrica de Muebles, S.A.
Ctra. Esquileo s/n
47639 · Villalba de los Alcores · Valladolid
ESPAÑA
Tlf. +34 983 721 596
sales@cancio.es
www.cancio.es

May 2018 Edition

NEWS 2018

Ce catalogue NEWS 2018 présente des nouveautés axées sur le secteur du salon, y compris des tables grand format (notamment des profondeurs de table de 100 cm) et surtout, une nouveauté importante: la table Kerala, premier modèle du marché qui intègre le Dekton comme matériau utilisé pour le plateau et les rallonges, dans toute la gamme de finitions (45).

Nous répondons également à une demande généralisée de notre clientèle: l'intégration de finitions epoxy (blanc, anthracite et noir) dans les pieds de la table sur mesure Multipla.

NEWS 2018

Unser neuer katalog Cancio-News 2018 konzentriert sich auf das thema: esstische, auch grosse tafel-tische, fest oder ausziehbar (einschliesslich neuer breiten von 100cm); und dem neuen wichtigen esstisch Kerala.

Kerala ist das erste Modell auf dem markt (als ess- und bar-tisch, fest oder ausziehbar) mit dem einzigartigen tischplatten-material Dekton in 45 verschiedenen Dekton-ausführungen, sowohl bei der tischplatte als auch bei den auszugsplatten.

CM-genauer wunschmass-tisch Multipla hier reagieren wir auf die grosse kunden-nachfrage mit optional bestellbaren beinen jetzt auch in stahl epoxy in schwarz, weiss oder anthrazit.

CANCIO
www.cancio.es

TABLE | TISH

TOKIO

N!



Plateau stratifié chêne naturel, pieds acier epoxy anthracite | Chaises Nuba, assises tapissées en Mystic anthracite et Mystic moutarde.
Tischplatte laminat in eiche natur, beine in stahl epoxy anthrazith | Stühle Nuba, gepolstert in Mystic anthrazith und senf.

110x70 | 120x80 | 140x90 | 160x90 | 180x90 | 160x100 | 180x100 | **220X100**



TABLE FIXE ET EXTENSIBLE | FIZE AND AUSZIEHBARE BAR

TOKIO



Plateau verre blanc brillant, pieds acier epoxy anthracite | Chaises City, assises tapissées en Scenic bleu.
Tischplatte in sicherheitsglas weiss, glanz, beine in stahl epoxy anthrazith | Stühle City, gepolstert in Scenic blau.

110x70 | **120x80** | 140x90 | 160x90 | 180x90 | 160x100 | 180x100 | 220x100



TABLE FIXE ET EXTENSIBLE | FIZE AND AUSZIEHBARE BAR

TOKIO N!



Plateau céramique Iron Moss, pieds acier epoxy blanc | Chaises Ole, assises tapissées en Mystic blanc et Mystic anthracite.
Tischplatte in porzellan-keramik Iron Moss, beine in stahl epoxy weiss | Stühle Ole, gepolsterte sitze in Mystic anthrazith und weiss

110x70 | 120x80 | 140x90 | **160x90** | 180x90 | 160x100 | 180x100 | 220x100

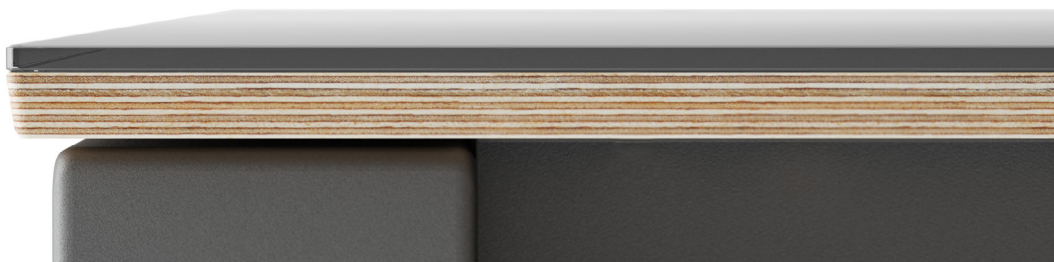

TABLE FIXE ET EXTENSIBLE | FIZE AND AUSZIEHBARE BAR

TOKIO



Plateau céramique Calacatta Silk, pieds acier epoxy blanc.
Tischplatte in porzellan-keramik Calacatta Silk, beine in stahl epoxy weiss.



Chants de table en céramique Nero, verre anthracite brillant, stratifié chêne naturel, pieds acier epoxy anthracite.
Tisch-ecken in porzellan-keramik Nero, sicherheitsglas anthrazit glanz, laminat eiche natur.

Table extensible ou fixe. Avec pieds métalliques laqués en epoxy, avec un mécanisme d'ouverture par déplacement des pieds avec des rallonges en forme de libre assorties au plateau principal.

Tisch in ausziehbar oder fest. Metall-Beine mit einem öffnungsmechanismus durch die verschiebung der beine und buchsystemverlängerung.

Table fixe
Geschlossener tisch

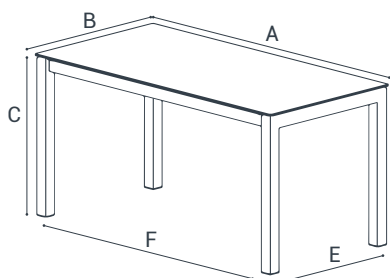

DIMENSIONS | MASSE:

cm	A	B	C	D	E	F			
110x70	110	70	75	55x1	55,8	96	1	4	6
120x80	120	80	75	60x1	65,8	106	1	6	8
140x90	140	90	75	60x1	75,8	126	1	6	8
160x90	160	90	75	43x2	75,8	146	2	8	10
180x90	180	90	75	43x2	75,8	166	2	8	12
160x100	160	100	75	50x2	87,8	146	2	8	10
180x100	180	100	75	50x2	87,8	166	2	8	12
220x100	220	100	75	50x2	87,8	206	2	10	14

Table extensible
Geöffneter tisch

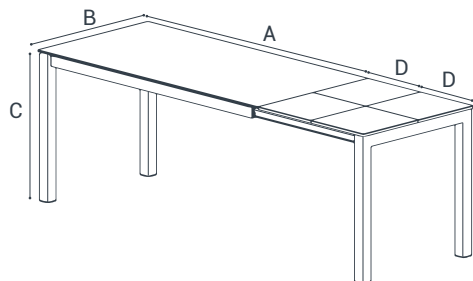

Places table fermé
Bartisch Sitzplatzkapazität



Nombre de rallonges
Anzahl der ausziehbaren



Nivellement allonge-plateau
Höhenausgleich
ausziehbaren-arbeitsfläche



Places table ouverte
Geöffneter Bartisch
Sitzplatzkapazität



Ouverture rallonges forme de livre
Ausziehbaren im buchformat



Frein par friction
Reibungsbremse

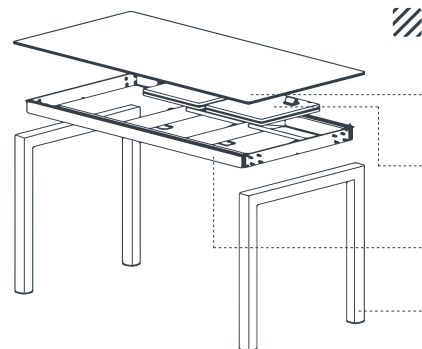

MATÉRIAUX | MATERIALIEN:

Plateau: Stratifié | Verre | Céramique
Arbeitsfläche: Laminat | Glas | Keramik

Rallonges: Stratifié | Verre | Céramique
Ausziehbare: Laminat | Glas | Keramik

Armature: Aluminium | Laminé haute pression
Gerüst: Aluminium | Verkleidet laminiert hochpression

Pied: Acier epoxy
Basis: Stahl epoxy



Section | Querschnitt:
70x70 mm



ÉPAISSEUR PLATEAU:
DICKE DER ARBEITSFLÄCHE:

Stratifié
Laminat

16mm



16 mm Stratifié | Laminat

Verre
Glas

21mm



+ 6 mm Verre trempé | Sicherheitsglas
+ 15 mm Contreplaqué | Sperrholz

Céramique
Keramik

11mm



+ 3 mm Céramique | Keramik
+ 8 mm Verré trempé | Sicherheitsglas

ÉPAISSEUR RALLONGES:
STARKE DER ERWEITERUNGSPLETTEN

16 mm Stratifié | Laminat

+ 4 mm Verré trempé | Sicherheitsglas
+ 15 mm Contreplaqué | Sperrholz

+ 3 mm Céramique | Keramik
+ 16 mm Fibracolor | Fibracolor







Vous pouvez faire un devis ou envoyer votre commande en utilisant notre secteur réservé: www.app.cancio.es













Sie können ihren auftrag erleiten oder ihres budget berechnen durch unsere online-anwendung: www.app.cancio.es

FINITIONS | AUSFÜHRUNGEN

PIEDS | BEINE

-  **Blanc**
Weiß
-  **Aluminium**
Aluminium
-  **Anthracite**
Anthrazit
-  **Noir**
Schwarz
-  **Bronzo**
Bronzo

PLATEAU | ARBEITSFLÄCHE

- Stratifié Laminat**
 - B**  **Blanc wax**
Weiß wax
 -  **Chêne Blanc**
Weiße eiche
 -  **Chêne Naturel**
Natürche eiche
- Verre Glass**
 - C**  **Anthracite Brillant**
Anthrazit Glanz
 -  **Noir Brillant**
Schwarz Glanz
 -  **Rouge Brillant**
Rot Glanz
 -  **Tourterelle Brillant**
Taupe Glanz
- D**  **Blanc Brillant**
Weiß Glanz
-  **Blanc Dépoli**
Matt Weiß
- Céramique Keramik**
 - E**  **Beton**
 -  **Cement**
 -  **Basalt**
 -  **Nero**
- F**  **Artic**
-  **Calacatta Silk**
-  **Iron Moss**

ARMATURE | GERÜST

 **Toujours la même couleur que les pieds**
Inmer die gleiche farbe wie arbeitsfläche

RALLONGES | AUSZIEHBARE

 **Toujours la même couleur que le plateau**
Inmer die gleiche farbe wie arbeitsfläche

POINTS | PUNKTE

		110x70	120x80	140x90	160x90	180x90	160x100	180x100	220x100	
PIED BEINE		Acier Epoxy Epoxy Stahl								
		TABLE EXTENSIBLE TISCH AUSZIEHBAR								
PLATEAU ARBEITS-FLÄCHE	Stratifié Laminat B	1076	1122	1208	1298	1343	1339	1399	1472	
	Verre Glas	C	1117	1181	1316	1410	1473	1516	1531	1679
		D	1141	1208	1342	1456	1504	1539	1560	1720
	Céramique Keramik	E	1205	1271	1427	1567	1630	1673	1721	1826
		F	1225	1293	1461	1609	1675	1721	1768	1882
			TABLE FIXE TISCH FIX							
PLATEAU ARBEITS-FLÄCHE	Stratifié Laminat B	808	832	878	896	930	942	972	1016	
	Verre Glas	C	863	904	970	996	1045	1062	1099	1180
		D	878	924	1003	1029	1064	1095	1147	1217
	Céramique Keramik	E	895	941	1032	1088	1115	1166	1218	1335
		F	908	956	1057	1117	1147	1193	1247	1382

TABLE FIXE ET EXTENSIBLE | FIZE AND AUSZIEHBARE BAR

MULTIPLA ^{N!}



Plateaux verre anthracite brillant, céramique Nero, céramique Beton, verre blanc brillant et dépoli, pieds epoxy anthracite, noir, aluminium anodisé, blanc.
Arbeitsfläche glas anthrazit glanz, keramik Nero, keramik Beton, glas Weiß glanz, weiß matt, beine epoxy anthrazit, schwarz, eloxiertes aluminium, weiß.

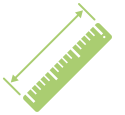

N!

Table Multipla avec pieds epoxy.
**+40 points sur le prix de la même table
avec pieds en aluminium.**

Tisch MULTIPLA mit beinen in epoxy, in
verschiedenen ausführungen. zusätzlich
+ 40 punkte auf den preis mit beinen in alu.



TABLE FIXE ET EXTENSIBLE | FIZE AND AUSZIEHBARE BAR

KERALA



Plateau Dekton Trilium, pieds acier epoxy anthracite | Fauteuil Aris, pieds acier anthracite, assises tapissées Camira Blazer Starley.
Tischplatte in Dekton-Trillum, Beine in stahl epoxy anthrazith | Armlehnenstuhl Aris, beine in stahl epoxy anthrazit, gepolstert in Camira Blazer Starley.

120x80 | 140x90 | **160x90** | 180x90 | 160x100 | 180x100



TABLE FIXE ET EXTENSIBLE | FIZE AND AUSZIEHBARE BAR

KERALA



120x80 | 140x90 | **160x90** | 180x90 | 160x100 | 180x100



Plateau Dekton Kelya, pieds bois chauffé | Chaises Atlas tapissées en Mystic blanc.
Tischplatte in Dekton Kelya, beine in buche massiv, farbe toast | Stühle Atlas, gepolstert in Mystic weiss.

120x80 | 140x90 | **160x90** | 180x90 | 160x100 | 180x100

KERALA



Plateau Dekton Nilium, pieds acier epoxy blanc | Tabourets Fantasy, assises polycarbonate fumé.
Tischplatte in Dekton Nilium, beine in stahl epoxy weiss | Barstuhl Fantasy, sitz in polcarbonat, Farbe Rauch.

TABLE FIXE ET EXTENSIBLE | TISCH FEST UND AUSZIEHBAR

KERALA

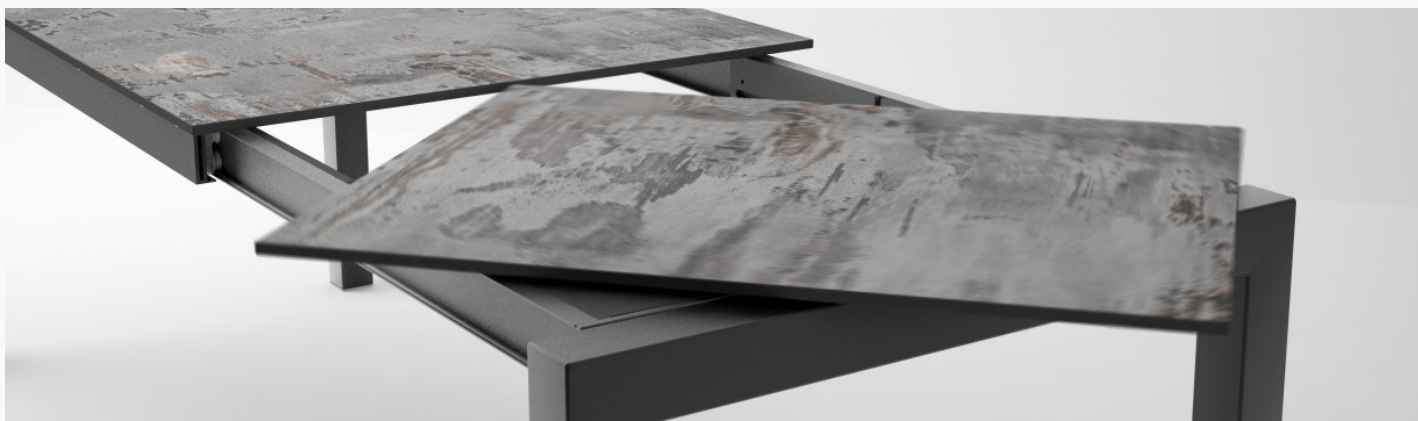

Séquence d'ouverture. Rallonge avec mécanisme pivotant. Plateau et rallonge avec panneau de protection acoustique. (Plateau Dekton Trilium).
Verlängerung. Schwenkmechanismus für die erweiterung. Tischplatte und verlängerung mit faserplatten-akustikschatz. (Tischplatte in Dekton Trilium).

DONNÉES TECHNIQUES | TECHNISCHE DATEN

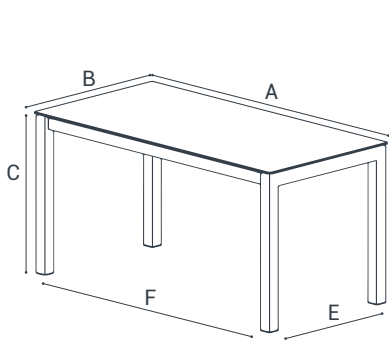
DIMENSIONS:
MASSE

cm	A	B	C	D	E	F			
120x80	120	80	75 90	60	65,5 67,8	106 105,4	1	6	8
140x90	140	90	75 90	70	75,5 77,8	126 125,4	1	6	8
160x90	160	90	75 90	70	75,5 77,8	146 145,4	1	8	10
180x90	180	90	75 90	70	75,5 77,8	166 165,4	1	8	12
160x100	160	100	75 90	80	85,5 87,8	146 145,4	1	8	10
180x100	180	100	75 90	80	85,5 87,8	166 165,4	1	8	12

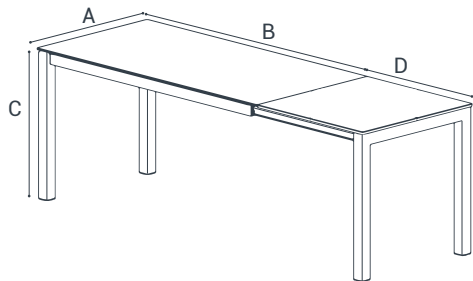
Places table ferméé
Bartisch sitzplätzekapazität

 Places table ouverte
Geöffneter tisch, sitzplätze.

 Nombre de rallonges
Anzahl der ausziehbaren

 Frein par friction
Reibungsbremse

 Version extensible
Ausziehbare ausführung

 Version fixe
Fixe ausführung

 Pied mobile avec roue
Bewegbares Bein mit Rad

MATÉRIAUX | MATERIALIEN

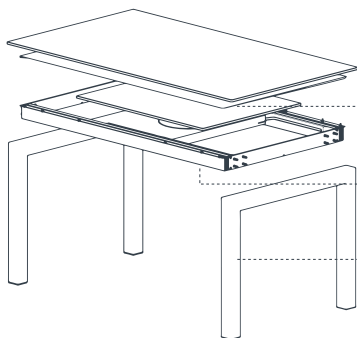
MATÉRIAUX | MATERIALIEN:
Plateau: Dekton + Protection acoustique
Arbeitsfläche: Dekton + Akustischer schutz

Armature: Aluminium | Laminé haute pression
Gerüst: Aluminium | Verkleidet laminiert hochpression

Pied: Acier epoxy | Bois
Beine: Epoxi stahl | Holz

 Section | Querschnitt:
70x70 mm | 73x64 mm

ÉPAISSEUR PLATEAU:
DICKE DER ARBEITSFLÄCHE:

Dekton 8mm 8 mm (Uniquement pour 120x80) Dekton
(nur für diese grösse 120x80) Dekton

Dekton 12mm 12 mm Dekton

ÉPAISSEUR RALLONGES:
DICKE DER ERWEITERUNGS-PLATTEN

8 mm Dekton

12 mm Dekton

 Vous pouvez faire un devis ou envoyer votre commande en utilisant notre secteur réservé: www.app.cancio.es

 Sie können ihren auftrag weiterleiten oder Ihr planungs-budget berechnen durch unsere online-anwendung: www.app.cancio.es

KERALA N!

FINITIONS | AUSFÜHRUNGEN



PLATEAU | ARBEITSFLÄCHE



DEKTON

ULTRACOMPACT SURFACES

Groupe I
Gruppe I

Edora Danae Fossil Kadum Sirius Sirocco Vegha

Aldem Blanc Concrete Borea Domoos Gada Galema Irok Kelya Keon Viena*

Groupe II
Gruppe II

Keranium Korus Makai* Ventus Nayla Nilium Orix Qatar* Radium Manhattan*

Strato Trilium Valterra Kira* Vera* Laos* Soke* Kreta* Lunar*

Groupe III
Gruppe III

Aura 15 Entzo Kairos Zenith Opera*

Blaze* Fiord* Glacier* Lumina* Spectra* Splendor*

Groupe IV
Gruppe IV

Natura* Tundra* Halo* Natura 18**

*XGLOSS

**Nouveauté | Neuheit

PIED | BEINE



Acier Epoxy Epoxy Stahl	Aluminium Aluminium	Anthracite Anthrazit	Blanc Weiß	Noir Schwarz	Bronzo Bronzo
Bois Teinté Gebeizt Holz	Blanchi Hell	Chauffé Dunkles	Canaletto Canaletto	Truffe Trüffel	
Bois Laqué Holz Lackiert	Anthracite Anthrazit	Blanc Weiß	Noir Schwarz		

ARMATURE | GERÜST

Toujours la même couleur que les pieds.
Immer die gleiche Farbe wie Beine.

RALLONGES | AUSZIEHBARE

Toujours la même couleur que le plateau.
Immer die gleiche Farbe wie Arbeitsfläche.

POINTS TABLE EXTENSIBLE 75cm | PUNKTE FÜR DEN AUSZIEHBAREN TISCH, HÖHE 75cm

		120x80	140x90	160x90	180x90	160x100	180x100	
PIEDS BEINE		Bois Holz						
		TABLE EXTENSIBLE AUSZIEHBAREN TISH						
PLATEAU ARBEITS-FLÄCHE	DEKTON	I	1624	1921	2016	2134	2153	2284
	ULTRACOMPACT SURFACES	II	1682	2011	2115	2241	2267	2408
	ULTRACOMPACT SURFACES	III	1748	2109	2223	2358	2392	2543
	ULTRACOMPACT SURFACES	IV	1841	2248	2375	2524	2568	2734
PIEDS BEINE		Acier Epoxy Epoxi stahl						
		TABLE EXTENSIBLE AUSZIEHBAREN TISH						
PLATEAU ARBEITS-FLÄCHE	DEKTON	I	1628	1935	2032	2140	2181	2310
	ULTRACOMPACT SURFACES	II	1686	2026	2131	2248	2296	2434
	ULTRACOMPACT SURFACES	III	1752	2124	2238	2365	2420	2569
	ULTRACOMPACT SURFACES	IV	1846	2263	2391	2530	2597	2760



POINTS TABLE SNACK EXTENSIBLE 90cm | BARTISCH, AUSZIEHBAR, HÖHE 90cm

		120x80	140x90	160x90	180X90	160X100	180X100	
PIEDS BEINE		Acier Epoxy Epoxi Stahl						
		TABLE EXTENSIBLE AUSZIEHBAREN TISH						
PLATEAU ARBEITS-FLÄCHE	 DEKTON® ULTRACOMPACT SURFACES	Groupe I	1668	1975	2072	2180	2221	2350
		II	1726	2066	2171	2288	2336	2474
		III	1792	2164	2278	2405	2460	2609
		IV	1886	2303	2431	2570	2637	2800

POINTS TABLE FIXE 75cm | PUNKTE ESSTISCH FEST, HÖHE 75cm

		120x80	140x90	160x90	180X90	160X100	180X100	
PIEDS BEINE		Bois Holz						
		TABLE FIXE ESSTISCH FEST						
PLATEAU ARBEITS-FLÄCHE	 DEKTON® ULTRACOMPACT SURFACES	Groupe I	1132	1297	1375	1499	1464	1536
		II	1170	1358	1427	1569	1542	1622
		III	1214	1423	1520	1657	1627	1716
		IV	1277	1517	1626	1778	1747	1850

		Acier Epoxy Epoxi Stahl						
		TABLE FIXE ESSTISCH FEST						
PLATEAU ARBEITS-FLÄCHE	 DEKTON® ULTRACOMPACT SURFACES	Groupe I	1136	1300	1373	1457	1486	1546
		II	1174	1360	1442	1534	1564	1632
		III	1218	1425	1517	1618	1650	1726
		IV	1281	1518	1623	1737	1655	1858

POINTS TABLE SNACK FIXE 90cm | BARTISCH, FEST, HÖHE 90cm

		120x80	140x90	160x90	180X90	160X100	180X100	
PIEDS BEINE		Acier Epoxy Epoxi Stahl						
		TABLE FIXE ESSTISCH FEST						
PLATEAU ARBEITS-FLÄCHE	 DEKTON® ULTRACOMPACT SURFACES	Groupe I	1176	1340	1413	1501	1526	1586
		II	1214	1400	1482	1574	1605	1672
		III	1258	1465	1557	1658	1691	1766
		IV	1321	1558	1663	1779	1812	1898

QUADRA NOVA

N! Nouvelles dimensions
Achtung! neu! weitere grösser

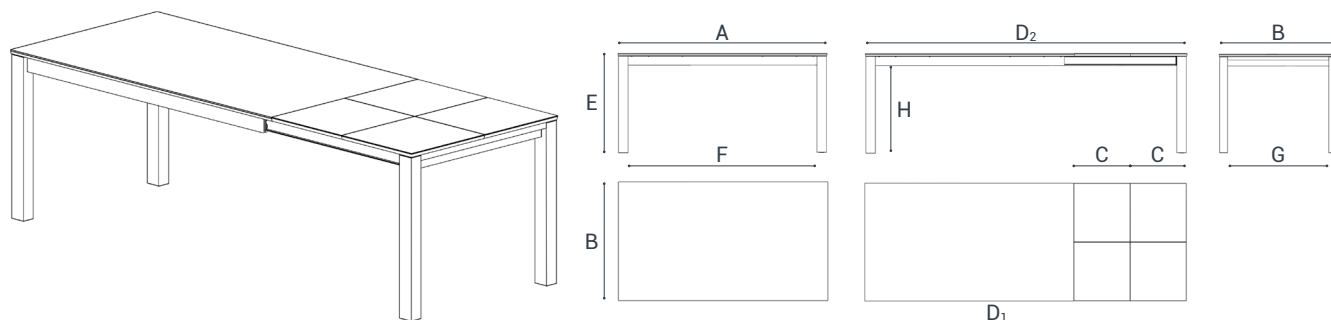

DONNÉES TECHNIQUES | TECHNISCHE ANGABEN

cm	A	B	C	D ₁	D ₂	E	F	G	H			
160x100	160	100	50x2	210	260	75	145,4	87,8	67	2	8	10
180x100	180	100	50x2	230	280	75	165,4	87,8	67	2	8	12

- Nombre de rallonges**
Anzahl der Ausziehbaren
- Places table fermée**
Sitzplätze Tisch geschlossen
- Places table ouverte**
Sitzplätze Tisch offen

- Version extensible**
Ausziehbare Ausführung
- Version fixe**
Fixe ausführung
- Section des pieds:**
Querschnitt des beins:
73x61 mm

- Ouverture rallonges forme de livre**
Ausziehbare im buchformat
- Pied mobile avec roue**
Bewegbares bein mit rad
- Frein par friction**
Reibungsbremse
- Nivellement allonge-plateau**
Höhenausgleich ausziehbaren-arbeitsfläche

MATÉRIAUX | MATERIALIEN

MATÉRIAUX:
MATERIALIEN:

Pieds: Bois de hêtre massif
Beine: Holz massiv buche

Armature: Aluminium | Laminé haute pression
Gerüst: Aluminium | Verkleidet laminiert hochpression

Plateau et Rallonges: Laminé | Verre | Céramique
Arbeitsfläche und Ausziehbare: Verkleidet Laminiert | Glas | Keramik



ÉPAISSEUR PLATEAU:
DICKE DER ARBEITSFLÄCHE:

- Laminé**
Laminiert 16mm | 16 mm Laminé | Verkleidet Laminiert
- Verre**
Glas 21mm | + 6 mm Verre | Glas
+ 15 mm Contreplaqué | Sperrholz
- Céramique**
Keramik 11mm | + 3 mm Céramique | Keramik
+ 8 mm Verre Trepmpé | Sicherheitsglas

ÉPAISSEUR RALLONGES:
DICKE DER AUSZIEHBARE:

- 16 mm Laminé | Verkleidet Laminiert
- + 4 mm Verre Trepmpé | Sicherheitsglas
+ 15 mm Contreplaqué | Sperrholz
- + 3 mm Céramique | Keramik
+ 16 mm Fibracolour | Fibracolour



FINITIONS | AUSFÜHRUNGEN



PIEDS | BEINE



Bois teinté
Gebeizt Holz



Blanchi
Hell



Chauffé
Dunkles



Canaletto
Canaletto



Truffe
Trüffel

Bois laqué
Holz lackiert



Blanc
Weiß



Anthracite
Anthrazit



Noir
Schwarz

PLATEAU | ARBEITSFLÄCHE



Laminé
Laminat

B



Blanc Wax
Weiß Wax

Verre
Glas

C



Anthracite Brillant
Anthrazit Glanz



Noir Brillant
Schwarz Glanz



Rouge Brillant
Rot Glanz



Tourterelle Brillant
Taupe Glanz

D



Blanc Brillant
Weiß Glanz



Blanc Dépoli
Weiß Matt

Céramique
Keramik

E



Beton



Cement



Basalt



Nero

F



Artic



Calacatta



Iron Moss

ARMATURE | GERÜST



Toujours la même couleur que les pieds
Immer die gleiche farbe wie beine

RALLONGES | AUSZIEHBARE



Toujours la même couleur que le plateau
Immer die gleiche farbe wie arbeitsfläche

POINTS | PUNKTE



PIEDS
BEINE



160x100

Bois | Holz

180x100

Bois | Holz

TABLE EXTENSIBLE | TISCH AUSZIEHBAR



Laminé
Laminat

B

1206

1254

Verre
Glas

C

1497

1582

D

1502

1553

Céramique
Keramik

E

1761

1848

F

1817

1905

PLATEAU
ARBEITSFLÄCHE

TABLE FIXE | TISCH FIX



Laminé
Laminat

B

854

933

Verre
Glas

C

969

1039

D

1014

1104

Céramique
Keramik

E

1021

1111

F

1058

1149

POIDS ET VOLUMES | GEWICHT UND VOLUMEN

TABLES | TISCHE



		Poids Gewicht	Volume total Gesamtvolumen	Colis Packs	Manipulation Manipulation
Tokio					
FIXE FESTSTEHENDE					
Stratifié Verkleidet	110x70	24,40	0,22	2	2
	120x80	28,25	0,27	2	2
	140x90	31,55	0,30	2	2
	160x90	34,00	0,33	2	2
	180x90	36,40	0,35	2	2
	160x100	35,50	0,35	2	2
	180x100	39,40	0,38	2	2
	220x100	45,50	0,41	2	2
Verre Glas	110x70	35,40	0,22	2	2
	120x80	41,00	0,27	2	2
	140x90	49,55	0,30	2	2
	160x90	54,55	0,33	2	2
	180x90	59,50	0,35	2	2
	160x100	58,00	0,35	2	2
	180x100	62,50	0,38	2	2
	220x100	65,50	0,41	2	2
Céramique Keramik	110x70	36,30	0,22	2	2
	120x80	42,15	0,27	2	2
	140x90	51,10	0,30	2	2
	160x90	56,30	0,33	2	2
	180x90	61,50	0,35	2	2
	160x100	61,00	0,35	2	2
	180x100	67,50	0,38	2	2
	220x100	79,50	0,41	2	2
EXTENSIBLE AUSZIEHBARE					
Stratifié Verkleidet	110x70	35,65	0,22	2	2
	120x80	40,29	0,26	2	2
	140x90	47,10	0,30	2	2
	160x90	54,40	0,33	2	2
	180x90	57,45	0,35	2	2
	160x100	56,00	0,35	2	2
	180x100	61,70	0,38	2	2
	220x100	68,50	0,41	2	2
Verre Glas	110x70	50,35	0,22	2	2
	120x80	58,60	0,26	2	2
	140x90	69,95	0,42	3	2
	160x90	82,55	0,47	3	2
	180x90	87,85	0,51	3	2
	160x100	87,00	0,49	3	2
	180x100	95,00	0,52	3	2
	220x100	104,00	0,56	3	2
Céramique Keramik	110x70	51,20	0,22	2	2
	120x80	58,45	0,27	2	2
	140x90	70,15	0,42	3	2
	160x90	82,10	0,47	3	2
	180x90	87,75	0,51	3	2
	160x100	89,00	0,49	3	2
	180x100	94,00	0,52	3	2
	220x100	107,00	0,56	3	2

		Poids Gewicht	Volume total Gesamtvolumen	Colis Packs	Manipulation Manipulation
Quadra Nova					
FIXE FIX					
Laminé Laminiert	160x100	35,00	0,35	2	2
	180x100	38,00	0,37	2	2
Verre Glas	160x100	56,50	0,35	2	2
	180x100	63,00	0,37	2	2
Céramique Keramik	160x100	59,00	0,35	2	2
	180x100	65,00	0,37	2	2
EXTENSIBLE AUSZIEHBARE					
Laminé Laminiert	160x100	55,00	0,35	2	2
	180x100	58,00	0,38	2	2
Verre Glas	160x100	87,00	0,49	3	2
	180x100	93,50	0,52	3	2
Céramique Keramik	160x100	88,00	0,49	3	2
	180x100	94,50	0,52	3	2

POIDS ET VOLUMES | GEWICHT UND VOLUMEN

TABLES | TISCHE



▼	Poids Gewicht 	Volume total Gesamtvolumen 	Colis Packs 	Manipulation Manipulation
---	----------------------	-----------------------------------	--------------------	----------------------------------

Kerala 75

FIXE | FESTSTEHENDE 75

PIEDS EPOXY | BEINE EPOXI STAHL

Dekton	120x80	75	0,27	2	2
	140x90	85	0,30	2	2
	160x90	95	0,33	2	2
	180x90	100	0,35	2	2
	160x100	100	0,35	2	2
	180x100	105	0,38	2	2

PIEDS BOIS | BEINE HOLZ

Dekton	120x80	60	0,27	2	2
	140x90	70	0,30	2	2
	160x90	80	0,33	2	2
	180x90	85	0,35	2	2
	160x100	85	0,35	2	2
	180x100	90	0,38	2	2

EXTENSIBLE | AUSZIEHBARE 75

PIEDS EPOXY | BEINE EPOXI STAHL

Dekton	120x80	89	0,27	2	2
	140x90	100	0,42	3	2
	160x90	120	0,47	3	2
	180x90	140	0,51	3	2
	160x100	129	0,49	3	2
	180x100	149	0,53	3	2

PIEDS BOIS | BEINE HOLZ

Dekton	120x80	74	0,27	2	2
	140x90	85	0,42	3	2
	160x90	105	0,47	3	2
	180x90	125	0,51	3	2
	160x100	114	0,49	3	2
	180x100	134	0,53	3	2

▼	Poids Gewicht 	Volume total Gesamtvolumen 	Colis Packs 	Manipulation Manipulation
---	----------------------	-----------------------------------	--------------------	----------------------------------

Kerala 90

FIXE | FESTSTEHENDE 90

PIEDS EPOXY | BEINE EPOXI STAHL

Dekton	120x80	77	0,28	2	2
	140x90	87	0,31	2	2
	160x90	97	0,34	2	2
	180x90	102	0,36	2	2
	160x100	102	0,36	2	2
	180x100	102	0,39	2	2

PIEDS BOIS | BEINE HOLZ

Dekton	120x80	62	0,28	2	2
	140x90	72	0,31	2	2
	160x90	82	0,34	2	2
	180x90	87	0,36	2	2
	160x100	87	0,36	2	2
	180x100	92	0,39	2	2

EXTENSIBLE | AUSZIEHBARE 90

PIEDS EPOXY | BEINE EPOXI STAHL

Dekton	120x80	91	0,28	2	2
	140x90	102	0,43	3	2
	160x90	122	0,48	3	2
	180x90	142	0,52	3	2
	160x100	131	0,50	3	2
	180x100	151	0,54	3	2

PIEDS BOIS | BEINE HOLZ

Dekton	120x80	76	0,28	2	2
	140x90	87	0,43	3	2
	160x90	107	0,48	3	2
	180x90	127	0,52	3	2
	160x100	116	0,50	3	2
	180x100	136	0,54	3	2

CANCIO
www.cancio.es